

DIODE MODULE

DD200HB

UL:E76102(M)

Power Diode Module **DD200HB** series are designed for various rectifier circuits. **DD200HB** has two diode chips connected in series and the mounting base is electrically isolated from elements for simple heatsink construction. Wide voltage rating up to 1,600V is available for various input voltage.

- Isolated mountings base
- Two elements in a package for simple (single and three phase) bridge connections
- Highly reliable glass passivated chips
- High Surge current Capability

(Applications)

Various rectifiers, Battery chargers, DC motor drives

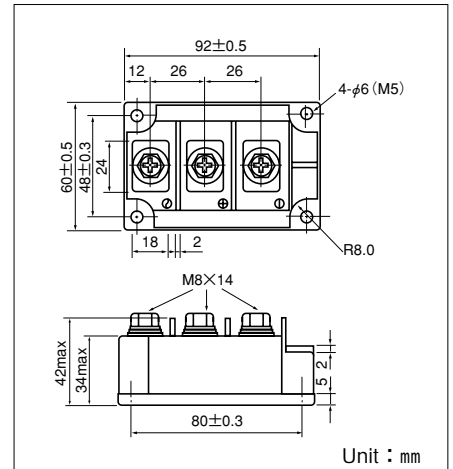
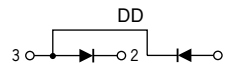

■ Maximum Ratings

(T_j=25°C unless otherwise specified)

Symbol	Item	Ratings		Unit
		DD200HB120	DD200HB160	
V _{RRM}	Repetitive Peak Reverse Voltage	1200	1600	V
V _{RSM}	Non-Repetitive Peak Reverse Voltage	1350	1700	V

Symbol	Item	Conditions	Ratings	Unit	
I _{F(AV)}	Average Forward Current	Single Phase, half wave, 180°C conduction, T _c : 96°C	200	A	
I _{F(RMS)}	R.M.S. Forward Current	Single Phase, half wave, 180°C conduction, T _c : 96°C	310	A	
I _{FSM}	Surge Forward Current	½ cycle, 50/60Hz, peak value, non-repetitive	5000/5500	A	
I ² t	I ² t	Value for one cycle of surge current	125000	A ² S	
T _j	Operating Junction Temperature		-40 to +150	°C	
T _{stg}	Storage Temperature		-40 to +125	°C	
V _{ISO}	Isolation Breakdown Voltage (R.M.S.)	A.C. 1 minute	2500	V	
	Mounting Torque	Mounting (M5)	Recommended Value 1.5-2.5 (15-25)	2.7 (28)	N·m (kgf·cm)
		Terminal (M8)	Recommended Value 8.8-10 (15-25)	11 (115)	
	Mass	Typical Value	510	g	

■ Electrical Characteristics

Symbol	Item	Conditions	Ratings	Unit
I _{RRM}	Repetitive Peak Reverse Current, max.	at V _{RRM} . Single phase, half wave, T _j =150°C	50	mA
V _{FM}	Forward Voltage Drop, max.	Forward current 600A, T _j =25°C, Inst. measurement	1.40	V
R _{th(j-c)}	Thermal Impedance, max.	Junction to case (Per a half module)	0.18	°C/W

Maximum Forward Characteristics

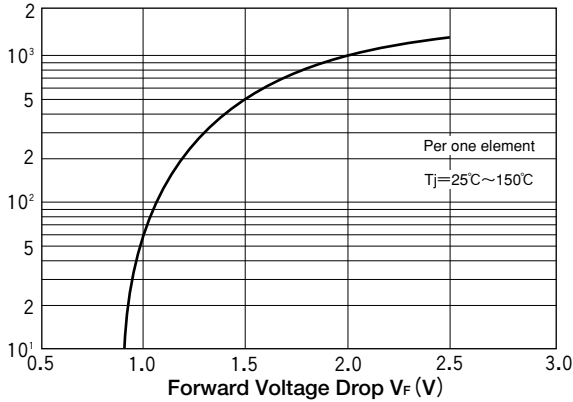

Average Forward Current vs. Power Dissipation

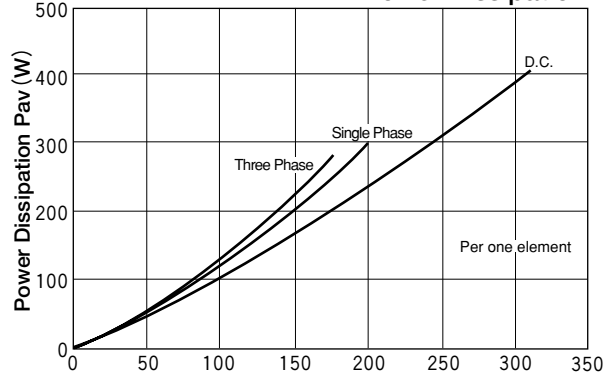

Average Forward Current vs. Allowable Case Temperature

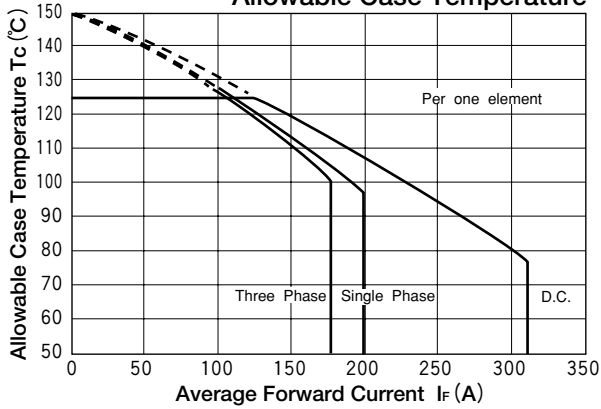

Cycle Surge Forward Current Rating (Non-Repetitive)

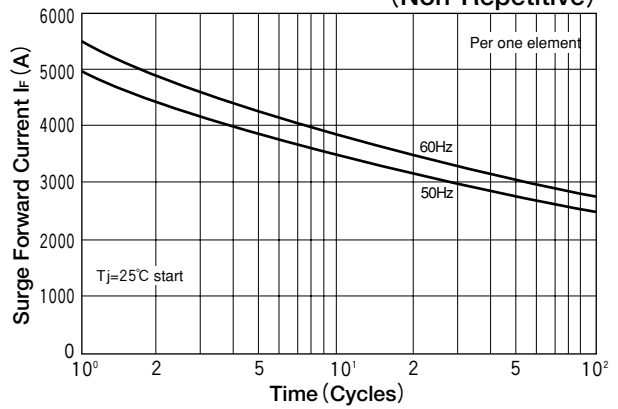

Transient Thermal Impedance

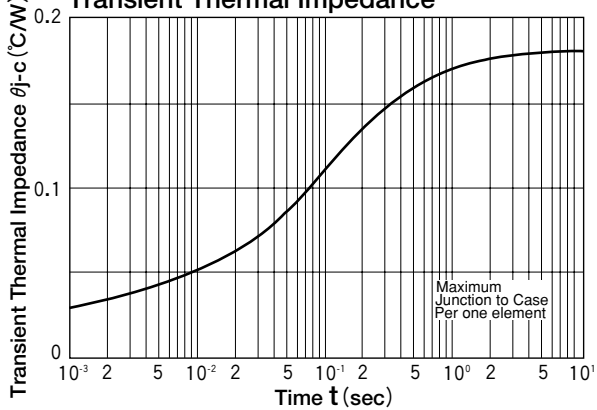

B2; Two Pulse Bridge connection

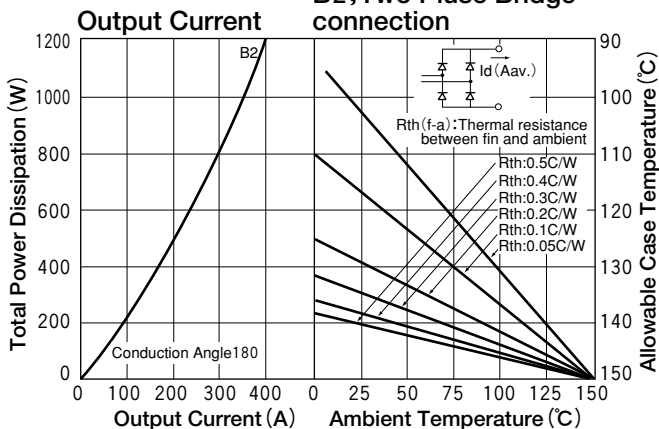

B6; Six pulse Bridge connection

